







Kombigerät RIT-TOOL SMART-FORCE

ID Nummer
1101159

**SMART
FORCE**
MORE THAN A RESCUE TOOL.



-  **18V BATTERY**
-  **POW3R PUMP**
-  **CONNECT**
-  **FORGED**
-  **360° HANDLE**
-  **LED LIGHTS**

Technische Daten:

Spreizweite	285 mm
Spreizkraft (im Arbeitsbereich)	30 - 1305 kN
Öffnungsweite	215 mm
Max. Zugkraft	47 kN
Gewicht (einsatzbereit)	14,2 kg
Abmessungen (LxBxH)	790 x 192 x 228 mm
EN-Klassifizierung (EN 13204)*	AC140H-14,2
EN-Schneidleistung (EN 13204)*	1H-2H-3H-4H-5H
NFPA-Schneidklasse (NFPA 1936)	A6-B7-C6-D7-E7-F3
DIN-Klasse (DIN 14751-4)	C100-H-E-I

Türöffner-Spitze
ID 1096859

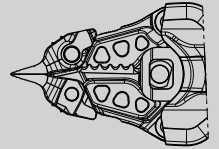

Spreizer-Spitze
ID 1050616

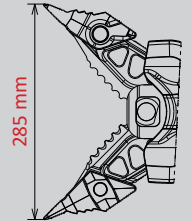

Lange-Spitze
ID 1051896

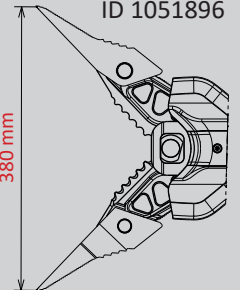

Zugaufsatz
ID 2836033

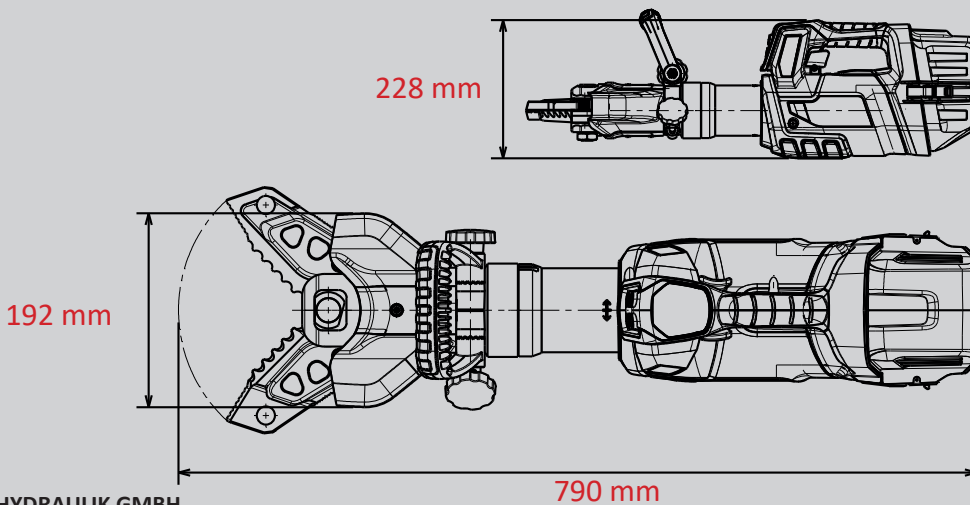
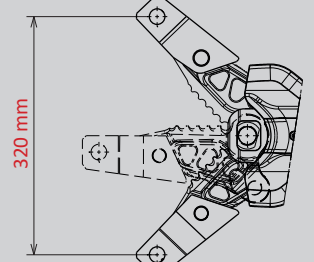

WEBER-HYDRAULIK GMBH
Heilbronner Straße 30
74363 Güglingen, Germany
Phone +49 7135 71-10270
info@weber-rescue.com

Emil Weber Platz 1
4460 Losenstein, Austria
Phone +43 7255 6237-120

*In Anlehnung an EN 13204. Abbildungen unverbindlich. Technische Änderungen vorbehalten.
09/2022C