

TELESCOPIC RESCUE CYLINDER RZT 2-1500

Part no.
1050041



 **DISTANCE**

 **PUSH CONTROL**

 **SINGLE**

Technical specifications:

Closed length (retracted)	650 mm
Final length (extended)	1500 mm
Stroke stage 1 / stroke stage 2	470 mm / 380 mm
Force stage 1 / force stage 2	189,4 kN / 99,0 kN
Weight	17,8 kg
Required oil volume	1,5 l
Dimensions (LxWxH)	650 X 88 X 200 mm
Nominal pressure	700 bar
EN classification (EN 13204)	TR189/470-99/380-17,8

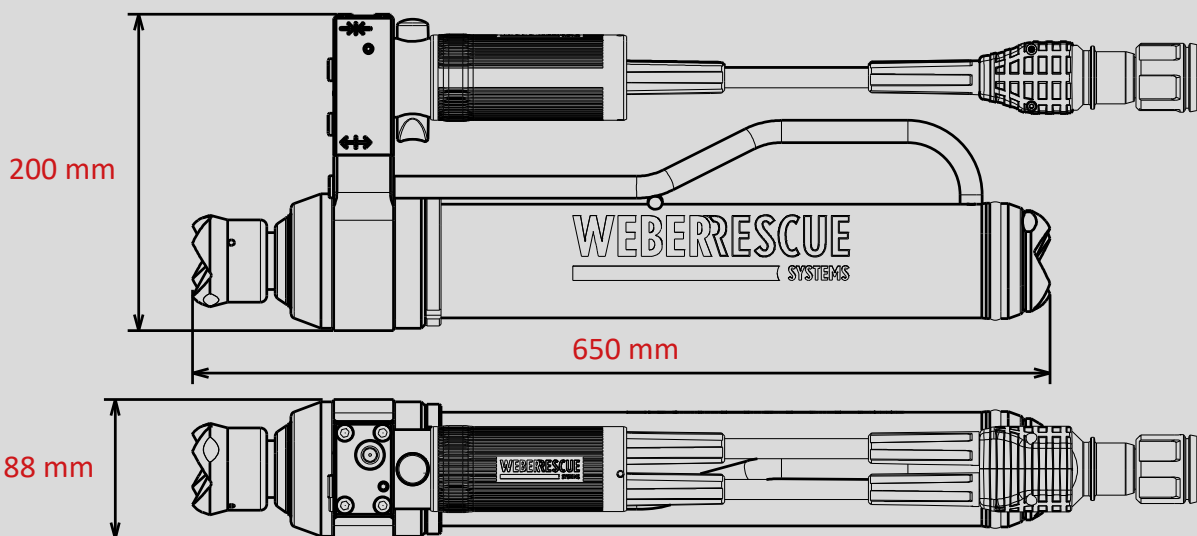

Images are non-binding. We reserve the right to technical modifications.
60005135 (-, -, ALL, 04.07.2019)