







Schneidgerät RSC 170 E-FORCE3

ID Nummer
1102148

E FORCE 3



-  FORGED
-  360° HANDLE
-  CHARGE
-  X-CHANGE
-  LED LIGHTS
-  SPEED CONTROL

Technische Daten:

Öffnungsweite	175 mm
Gewicht (einsatzbereit)	18,1 kg
Abmessungen (LxBxH)	889 X 236 X 241 mm
Nenndruck	700 bar
EN-Klassifizierung (EN 13204)	BC166I-18,1
EN-Schneidleistung (EN 13204)	1J-2K-3I-4J-5J
NFPA-Schneidklasse (NFPA 1936)	A7-B8-C6-D8-E9-F4

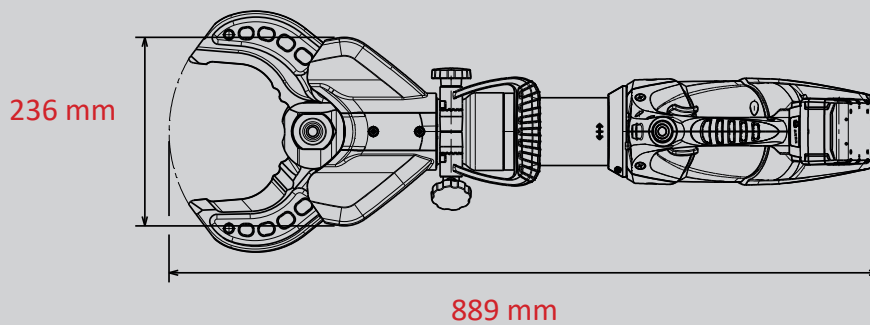
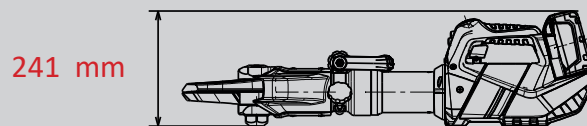

WEBER-HYDRAULIK GMBH
Heilbronner Straße 30
74363 Güglingen, Germany
Phone +49 7135 71-10270
info@weber-rescue.com

Emil Weber Platz 1
4460 Losenstein, Austria
Phone +43 7255 6237-120

Abbildungen unverbindlich. Technische Änderungen vorbehalten.
2022B, 10/2022