







Cizalla RSC 170 PLUS

N° de piezas
1101568



-  FORGED
-  360° HANDLE
-  PLUS
-  SINGLE
-  X-CHANGE
-  PUSH CONTROL

Datos técnicos:

Apertura	175 mm
Peso (operativo)	15,4 kg
Dimensiones (LxAnxAI)	732 x 236 x 164 mm
Presión nominal	700 bar
Clasificación EN (EN 13204)	BC166I-15,4
Rendimiento de corte EN (EN 13204)	1J-2K-3I-4J-5J
Clase de corte NFPA (NFPA 1936)	A7-B8-C6-D8-E9-F4

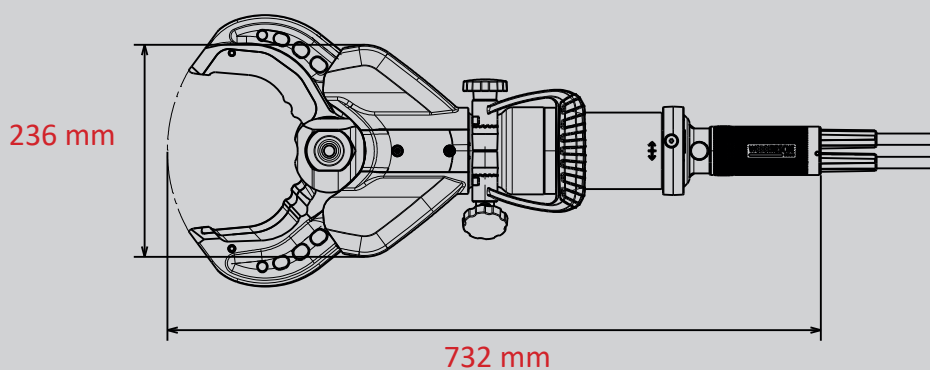
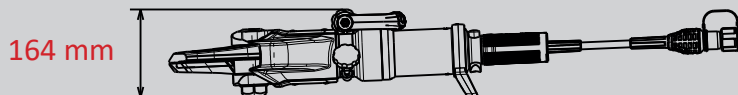

WEBER-HYDRAULIK GMBH
Heilbronner Straße 30
74363 Güglingen, Germany
Phone +49 7135 71-10270
info@weber-rescue.com

Emil Weber Platz 1
4460 Losenstein, Austria
Phone +43 7255 6237-120

Las ilustraciones únicamente son indicativas. Reservado el derecho a introducir modificaciones técnicas.
2022B; 107/2022