







Cisaille RSC 170 PLUS

Référence
1101568



-  FORGED
-  360° HANDLE
-  PLUS
-  SINGLE
-  X-CHANGE
-  PUSH CONTROL

Caractéristiques techniques :

Largeur d'ouverture	175 mm
Poids (opérationnel)	15,4 kg
Dimensions (LxlxH)	732 x 236 x 164 mm
Pression nominale	700 bar
Classification EN (DIN EN 13204)	BC166I-15,4
Puissance de coupe EN (EN 13204)	1J-2K-3I-4J-5J
Classification NFPA (NFPA 1936)	A7-B8-C6-D8-E9-F4

164 mm

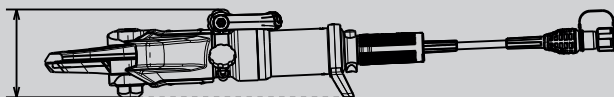

236 mm

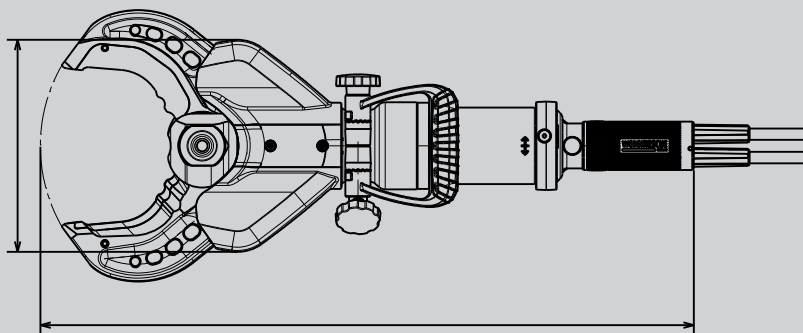

732 mm

WEBER-HYDRAULIK GMBH
Heilbronner Straße 30
74363 Güglingen, Germany
Phone +49 7135 71-10270
info@weber-rescue.com

Emil Weber Platz 1
4460 Losenstein, Austria
Phone +43 7255 6237-120

Images non contractuelles. Toutes modifications techniques réservées.
2022B; 107/2022