







CESOIA RSC 170 PLUS

Articolo
1101568



-  **FORGED**
-  **360° HANDLE**
-  **PLUS**
-  **SINGLE**
-  **X-CHANGE**
-  **PUSH CONTROL**

Dati tecnici

Apertura	175 mm
Peso (compreso batteria)	15,4 kg
Dimensioni LxLxA	732 x 236 x 164 mm
Pressione nominal	700 bar
Classificazione EN 13204	BC166I-15,4
Forza di taglio EN	1J-2K-3I-4J-5J
Classificazione NFPA	A7-B8-C6-D8-E9-F4

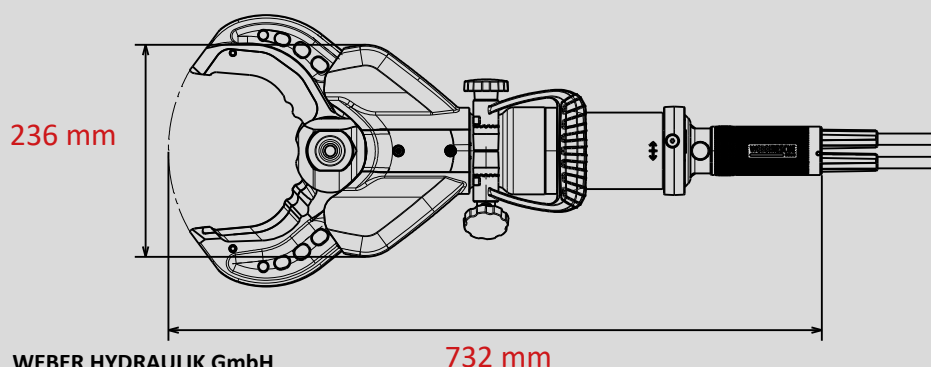
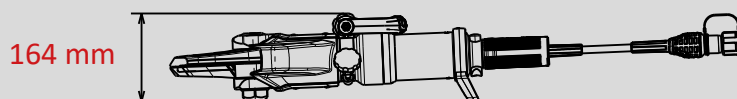

WEBER-RESCUE-ITALIA-SRL
Zona Artigianale 21, I-39052
Caldaro (BZ)
Phone +39 0471 1701141
Fax +39 0471 633977

WEBER HYDRAULIK GmbH
Emil Weber Platz 1
4460 Losenstein, Austria
Phone +43 7255 6237-120

Le illustrazioni non sono vincolanti. Soggetto a modifiche tecniche.
2022B; 107/2022