







# Cutter RSC 190 PLUS

Part no.  
1101569



-  FORGED
-  360° HANDLE
-  PLUS
-  SINGLE
-  X-CHANGE
-  PUSH CONTROL

## Technical data:

Opening width	185 mm
Weight	17,8
Oil needs	0,2
Dimensions (LxWxH)	758 x 236 x 164 mm
Nominal pressure	700 bar
EN cutting class (EN 13204)	BC187K-17,8
EN cutting performance (EN 13204)	1K-2K-3K-4K-5K
NFPA cutting class (NFPA 1936)	A8-B9-C7-D9-E9-F4

164 mm

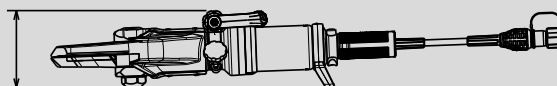

236 mm

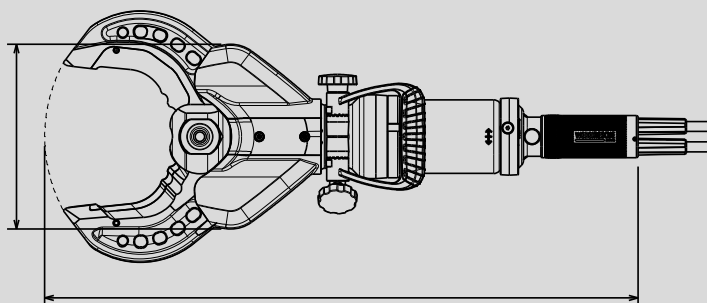

758 mm

### WEBER-HYDRAULIK GMBH

Heilbronner Straße 30  
74363 Güglingen, Germany  
Phone +49 7135 71-10270  
info@weber-rescue.com

Emil Weber Platz 1  
4460 Losenstein, Austria  
Phone +43 7255 6237-120

Images are non-binding. We reserve the right to technical modifications.  
2022A, 05/2022