







# Schneidgerät RSC 190 PLUS

ID Nummer  
1101569



-  FORGED
-  360° HANDLE
-  PLUS
-  SINGLE
-  X-CHANGE
-  PUSH CONTROL

## Technische Daten:

Öffnungsweite	187 mm
Gewicht	17,8 kg
Abmessungen (LxBxH)	758 x 236 x 164
Nenndruck	700 bar
EN-Klassifizierung (EN 13204)	BC187K-17,8
EN-Schneidleistung (EN 13204)	1K-2K-3K-4K-5K
NFPA-Schneidklasse (NFPA 1936)	A8-B9-C7-D9-E9-F4

164 mm

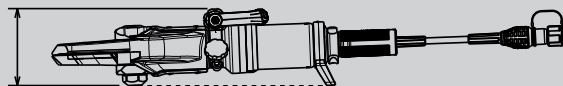

236 mm

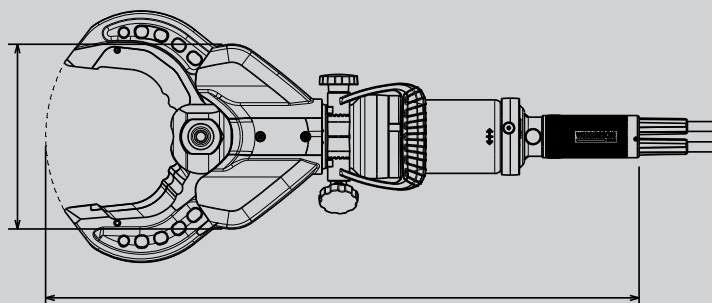

758 mm

### WEBER-HYDRAULIK GMBH

Heilbronner Straße 30  
74363 Güglingen, Germany  
Phone +49 7135 71-10270  
info@weber-rescue.com

Emil Weber Platz 1  
4460 Losenstein, Austria  
Phone +43 7255 6237-120

Abbildungen unverbindlich. Technische Änderungen vorbehalten.  
2022A\_05/2022