







CESOIA RSC 190 PLUS

Articolo
1101569



-  FORGED
-  360° HANDLE
-  PLUS
-  SINGLE
-  X-CHANGE
-  PUSH CONTROL

Dati tecnici

Apertura	187 mm
Peso (compreso batteria)	17,8 kg
Dimensioni LxLxA	758 x 236 x 164
Pressione nominal	700 bar
Classificazione EN 13204	BC187K-17,8
Forza di taglio EN	1K-2K-3K-4K-5K
Classificazione NFPA	A8-B9-C7-D9-E9-F4

164 mm

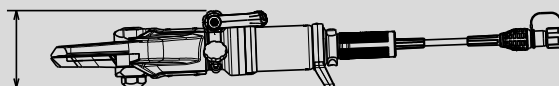

236 mm

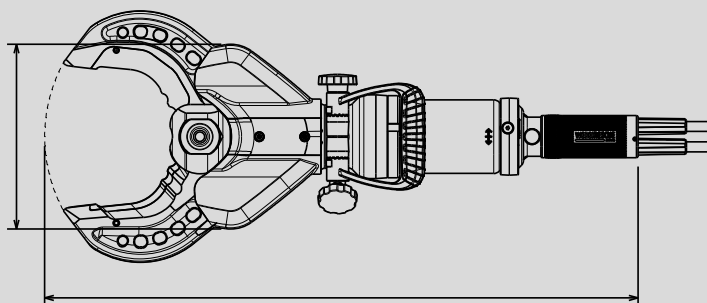

758 mm

WEBER-RESCUE-ITALIA-SRL
Zona Artigianale 21, I-39052
Caldaro (BZ)
Phone +39 0471 1701141
Fax +39 0471 633977

WEBER HYDRAULIK GmbH
Emil Weber Platz 1
4460 Losenstein, Austria
Phone +43 7255 6237-120

Le illustrazioni non sono vincolanti. Soggetto a modifiche tecniche.
2022A_05/2022