











Cisaille RSC 200 PLUS SMART-FORCE

Référence
1101552

**SMART
FORCE**
MORE THAN A RESCUE TOOL.



-  **SMOOTH CUT**
-  **18V BATTERY**
-  **POW3R PUMP**
-  **CONNECT**
-  **FORGED**
-  **360° HANDLE**
-  **PLUS**
-  **LED LIGHTS**
-  **UNDERWATER**
-  **X-CHANGE**

Caractéristiques techniques :

Largeur d'ouverture	202 mm
Poids (opérationnel)	26,9 kg
Dimensions (LxlxH)	1005 x 296 x 228 mm
Pression nominale	700 bar
Classification EN (DIN EN 13204)	CC202K-26,9
Puissance de coupe EN (EN 13204)	1K-2K-3K-4K-5K
Classification NFPA (NFPA 1936)	A9-B9-C9-D9-E9-F5

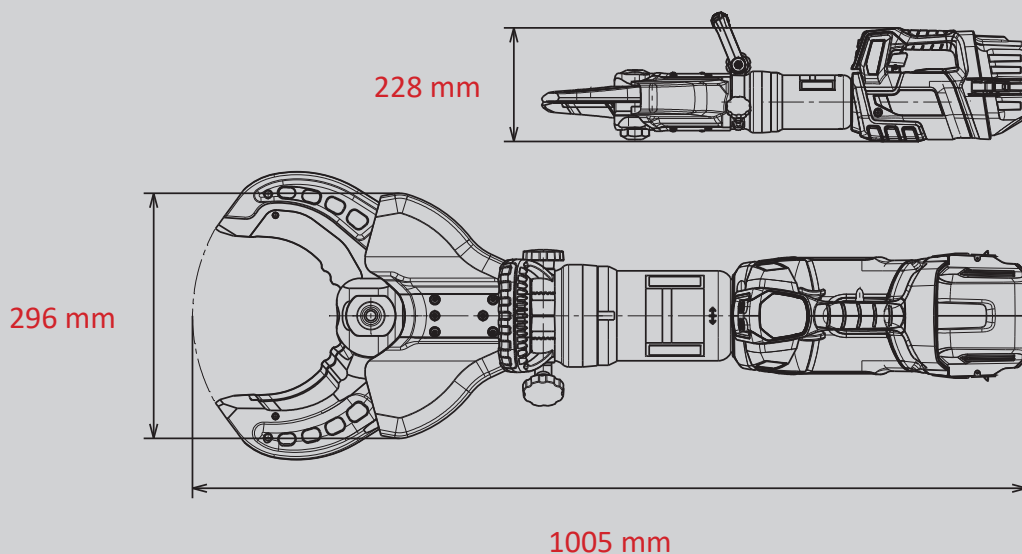

Images non contractuelles. Toutes modifications techniques réservées.
01/2025A