







Schneidgerät RSC 170 PLUS

ID Nummer
1101568



-  **FORGED**
-  **360° HANDLE**
-  **PLUS**
-  **SINGLE**
-  **X-CHANGE**
-  **PUSH CONTROL**

Technische Daten:

Öffnungsweite	175 mm
Gewicht	15,3 kg
Ölbedarf	0,1l
Abmessungen (LxBxH)	727 X 236 X 164 mm
Nenndruck	70 bar
EN-Klassifizierung (EN 13204)	BC166I-15,3
EN-Schneidleistung (EN 13204)	1J-2K-3I-4J-5J
NFPA-Schneidklasse (NFPA 1936)	A7-B8-C6-D8-E9-F4

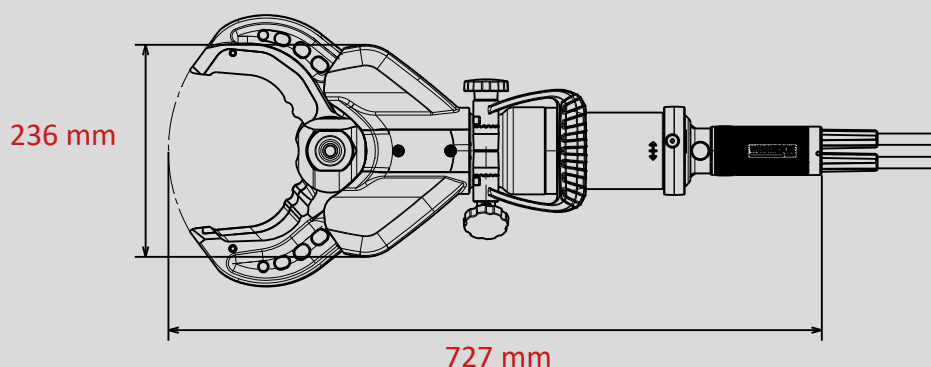
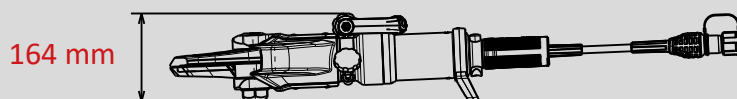

WEBER-HYDRAULIK GMBH
Heilbronner Straße 30
74363 Güglingen, Germany
Phone +49 7135 71-10270
info@weber-rescue.com

Emil Weber Platz 1
4460 Losenstein, Austria
Phone +43 7255 6237-120

Abbildungen unverbindlich. Technische Änderungen vorbehalten.
2022A, 05/2022