







Cutter RSC 170 PLUS

Part no.
1101568



-  FORGED
-  360° HANDLE
-  PLUS
-  SINGLE
-  X-CHANGE
-  PUSH CONTROL

Technical data:

Opening width	175 mm
Weight	15,3 kg
Oil needs	0,1l
Dimensions (LxWxH)	727 X 236 X 164 mm
Nominal pressure	70 bar
EN cutting class (EN 13204)	BC166I-15,3
EN cutting performance (EN 13204)	1J-2K-3I-4J-5J
NFPA cutting class (NFPA 1936)	A7-B8-C6-D8-E9-F4

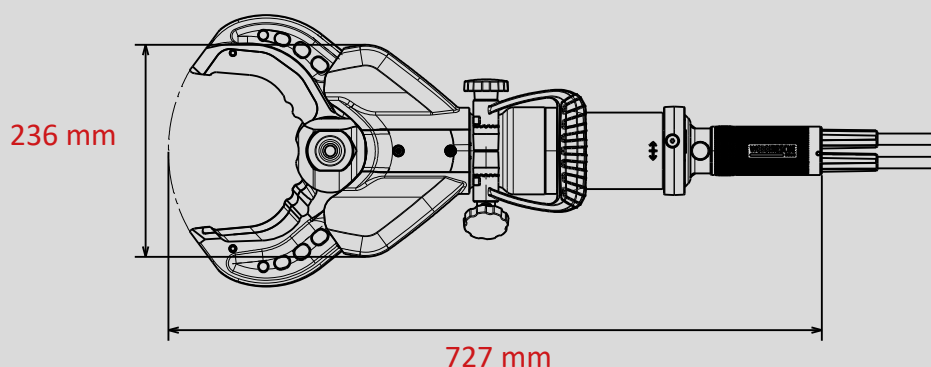
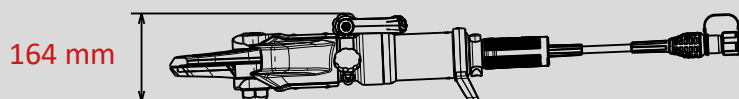

WEBER-HYDRAULIK GMBH
Heilbronner Straße 30
74363 Güglingen, Germany
Phone +49 7135 71-10270
info@weber-rescue.com

Emil Weber Platz 1
4460 Losenstein, Austria
Phone +43 7255 6237-120

Images are non-binding. We reserve the right to technical modifications.
2022A, 05/2022