







# SCHNEIDGERÄT RSU 180 PLUS

Teile-Nr.  
**1093279**



-  **FORGED**
-  **360° HANDLE**
-  **PLUS**
-  **PUSH CONTROL**
-  **SINGLE**
-  **X-CHANGE**
-  **ULTIMATE**

## Technische Daten:

Öffnungsweite	185 mm
Gewicht (einsatzbereit)	16,7 kg
Ölbedarf	0,2 l
Abmessungen (LxBxH)	737 x 236 x 159 mm
Nenndruck	700 bar
EN-Klassifizierung (EN 13204)	BC185J-16,7
EN-Schneidleistung (EN 13204)	1J-2K-3K-4K-5K
NFPA-Schneidklasse (NFPA 1936)	A8-B9-C7-D9-E9-F4

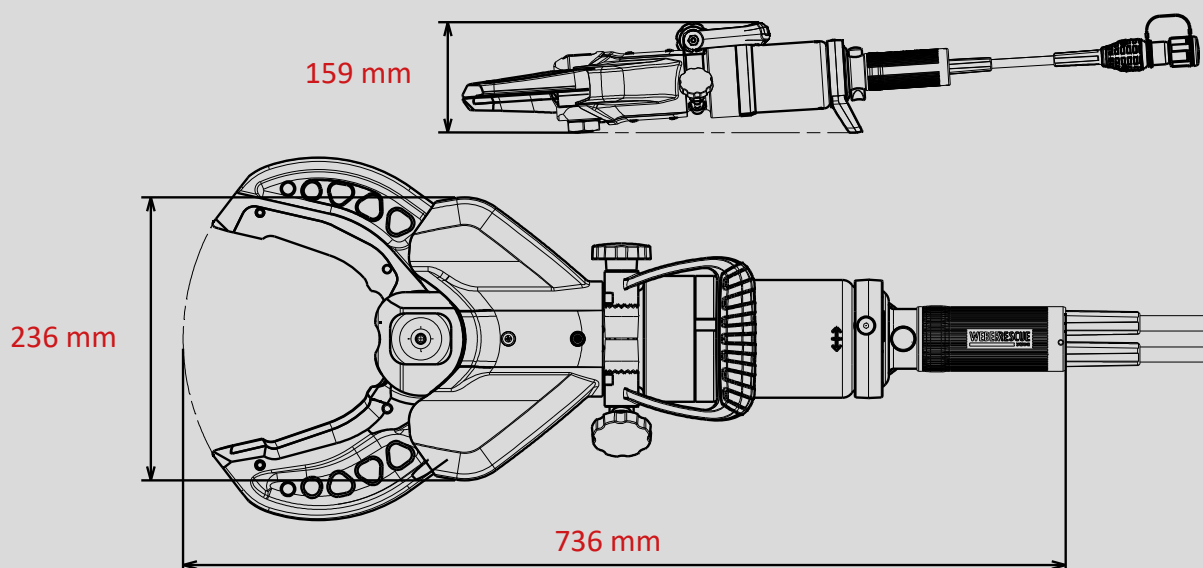

Abbildungen unverbindlich. Technische Änderungen vorbehalten.  
60004803 (190581, A, ALL, 26.06.2019)