







CISAILLE RSU 180 PLUS

Réf. pièce
1093279



-  **FORGED**
-  **360° HANDLE**
-  **PLUS**
-  **PUSH CONTROL**
-  **SINGLE**
-  **X-CHANGE**
-  **ULTIMATE**

Caractéristiques techniques :

| | |
|----------------------------------|--------------------|
| Largeur d'ouverture | 185 mm |
| Poids (opérationnel) | 16,7 kg |
| Consommation d'huile | 0,2 l |
| Dimensions (LxlxH) | 737 x 236 x 159 mm |
| Pression nominale | 700 bar |
| Classification EN (DIN EN 13204) | BC185J-16,7 |
| Puissance de coupe EN (EN 13204) | 1J-2K-3K-4K-5K |
| Classification NFPA (NFPA 1936) | A8-B9-C7-D9-E9-F4 |

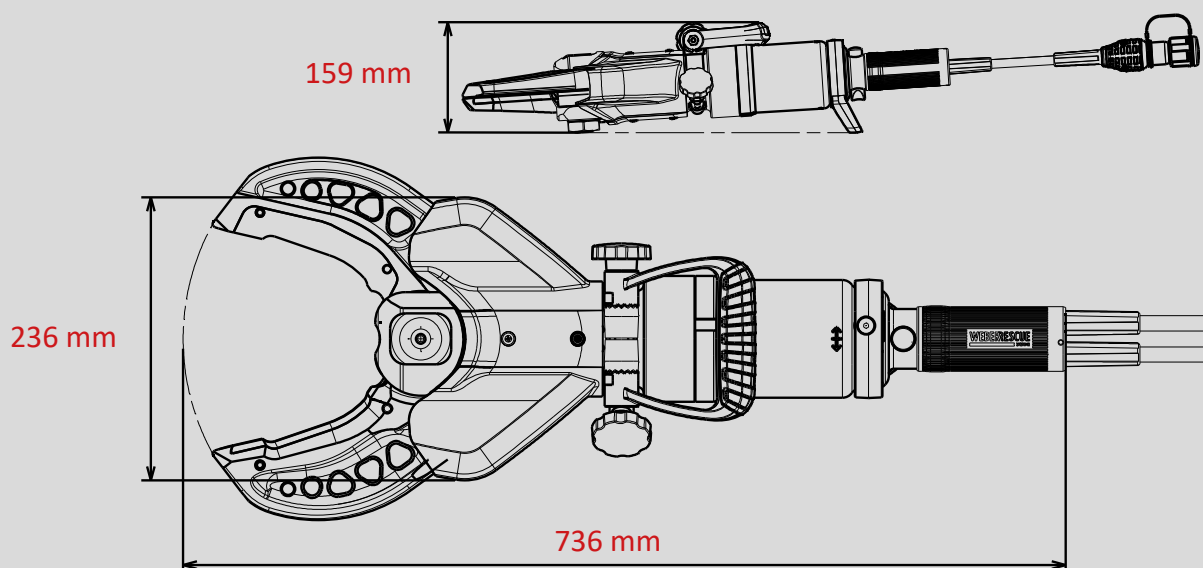

Images non contractuelles. Toutes modifications techniques réservées.
60004803 (190581, A, ALL, 26.06.2019)