







ÉCARTEUR SP 50 BS

Réf. pièce
1090581



-  GRIP
-  LIGHTWEIGHT
-  PEELING
-  PUSH CONTROL
-  SINGLE
-  X-CHANGE

Caractéristiques techniques:

Largeur d'écartement	805 mm
Force d'écartement (dans la zone de travail)	50 - 501 kN
Force d'écrasement max.	144,0 kN
Largeur de traction	680 mm
Force de traction max.	67 kN
Poids	17,0 kg
Consommation d'huile	0,2 l
Dimensions (LxlxH)	854 x 282 x 200 mm
Pression nominale	700 bar
Classification EN (DIN EN 13204)	BS50/805-17,0

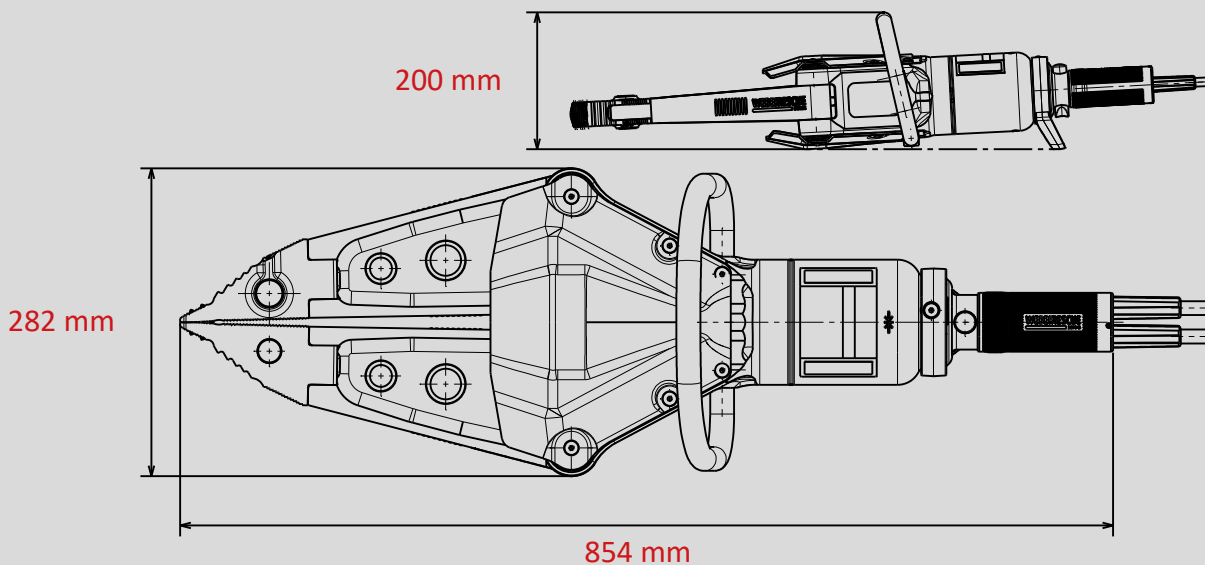

Images non contractuelles. Toutes modifications techniques réservées.
60004638 (-, -, ALL, 1.1.10.2019)